



Hope Chest

Plan No. 885

Copyright U-Build, Inc., 2003.
All rights reserved. Printed in the U.S.A.

A perfect marriage of form and function, this traditional hope chest is as useful in the den, dining room or hall as it is in the bedroom. The project is great for extra linens, but the large storage compartment and generous drawer work just as well for games, CDs, DVDs, scarves and mittens, table linens or almost anything else. And the handsome Craftsman style complements any decor.

The hope chest measures 36 inches long by 24 inches tall by 21 inches deep.

Bill of Material

Quantity	Size	Material	Item
1	3/4" x 48" x 48"	pine plywood	E, F
1	1/2" x 48" x 48"	mahogany* plywood	L, M, N
1	1/2" x 24" x 48"	Douglas fir plywood	D
16 bd. ft.	3/4"	lumber of choice	A, B, C, G, H, I, J, K, O
16	3/8" x 2"	dowels**	
1 pair	18"	full-extension drawer slides	
1 pair	2"	butt hinges	
2	1"	knobs	
1		lid support	
1 box	1"	finish nails	
1 box	1 1/2"	finish nails	
		birch plugs	
1 can		wood filler	
1 bottle		wood glue	
1 quart		finish of choice	

*This plywood may be labelled "luan"

**Biscuits may be substituted for dowels

Cutting Schedule

(Some boards may require edge-gluing to achieve width)

Item	Qty	T	W	L	Material
A	4	3/4"	3"	23 1/4"	pine
B	2	3/4"	3"	14"	pine
C	2	3/4"	3"	14"	pine
D	2	1/2"	14 3/4"	17"	Douglas fir plywood
E	1	3/4"	22 1/4"	33 1/2"	pine plywood
F	1	3/4"	19"	33 1/2"	pine plywood
G	1	1/4"	3/4"	33 1/2"	pine
H	1	3/4"	10 1/2"	33 1/2"	pine
I	1	3/4"	3"	33 1/2"	pine
J	1	3/4"	3"	36"	pine
K	1	3/4"	18"	36"	pine
L	2	1/2"	7 5/8"	18 1/4"	mahogany plywood
M	2	1/2"	6 5/8"	31 1/2"	mahogany plywood
N	1	1/2"	18 1/4"	32"	mahogany plywood
O	1	3/4"	7 7/8"	33 3/8"	pine

NOTES

1. Read manufacturer's instructions before operating equipment.
2. **Always** wear safety glasses.
3. Use glue and 1 1/2" finish nails on all joints unless otherwise noted.
4. We used pine for this project, but any veneer plywood and matching lumber (such as oak, birch or maple) will work equally well.

Plywood Cutting Layouts

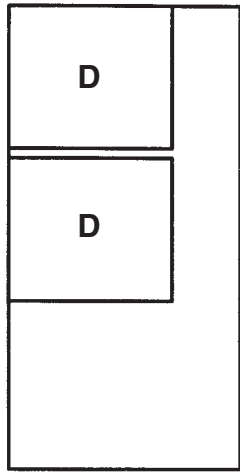

1/2" x 24" x 48"
Douglas fir plywood

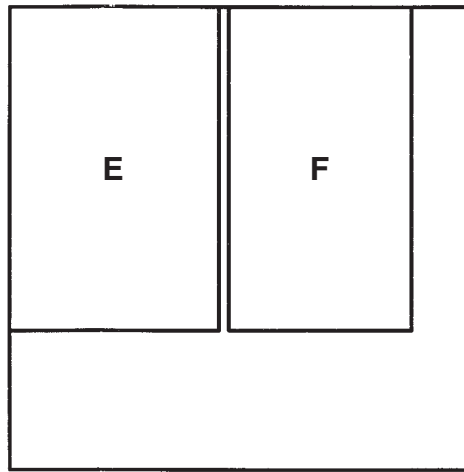

3/4" x 48" x 48"
Pine plywood

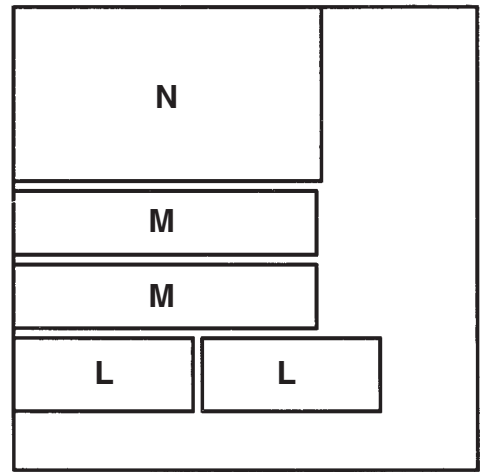

1/2" x 48" x 48"
Mahogany plywood

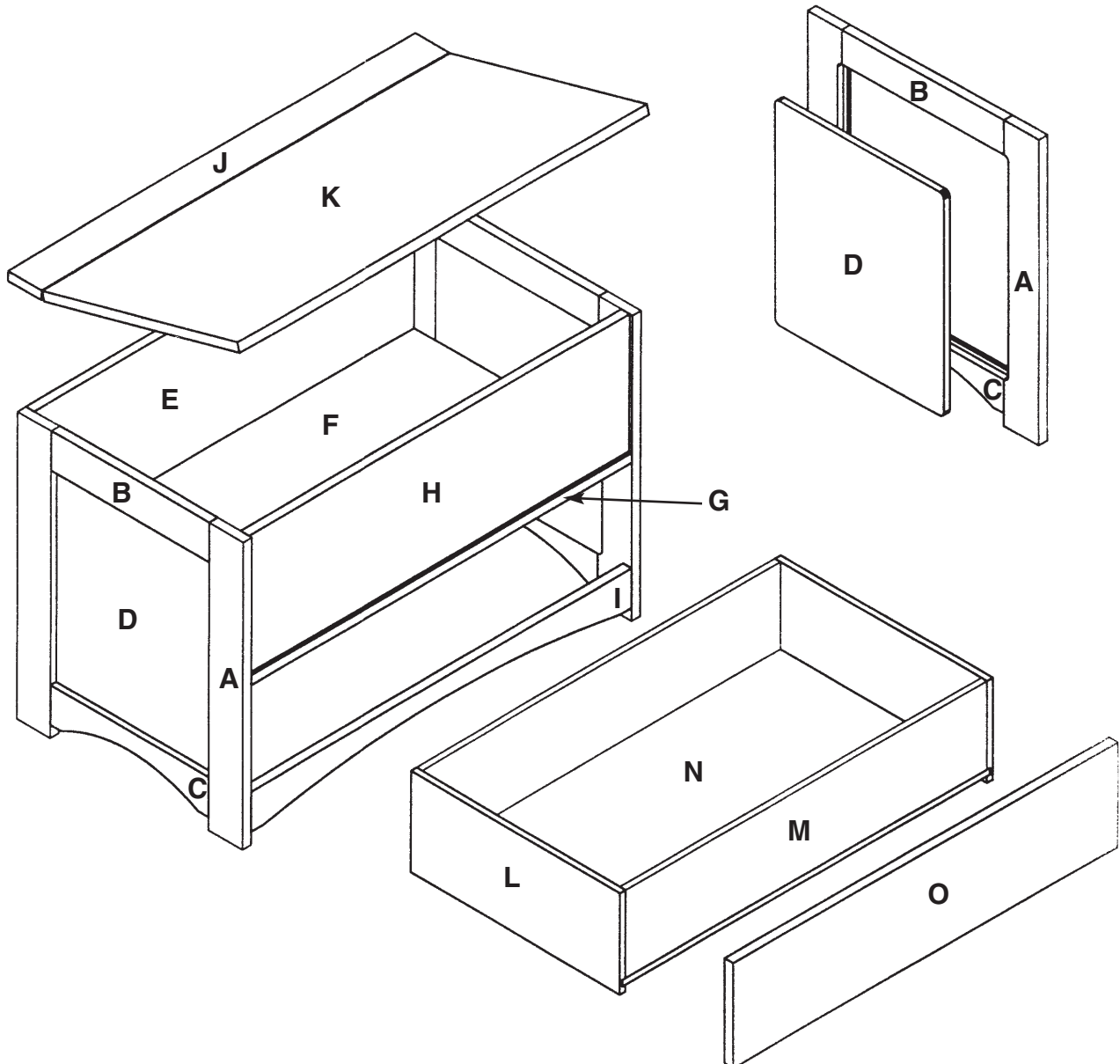

Assembly Instructions

Page One

Read all instructions before beginning any work. Cut all material to sizes shown in cutting schedule.

1. Lay out and cut curves on boards (C), (E) and (I). Refer to Figures 1 and 2.

Figure 1
Board (C) Curve Layout

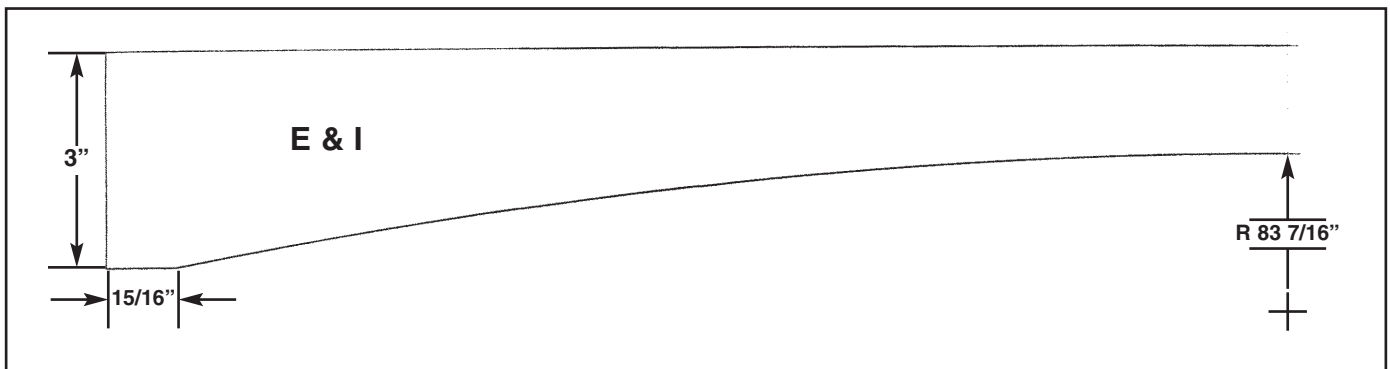
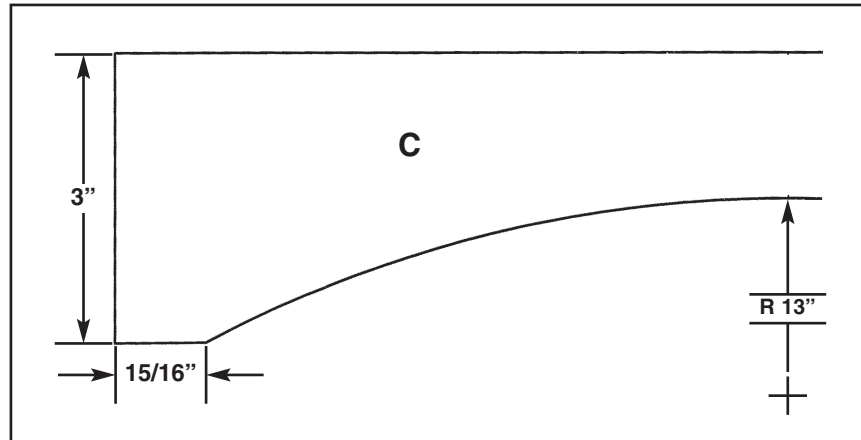

Figure 2
Board (E) and (I) Curve Layout

2. Attach board (G) to board (F) using glue and 1" finish nails. Refer to Figure 3.
3. Attach board (E) to board (F) using 1 1/2" finish nails. Refer to Figure 3.

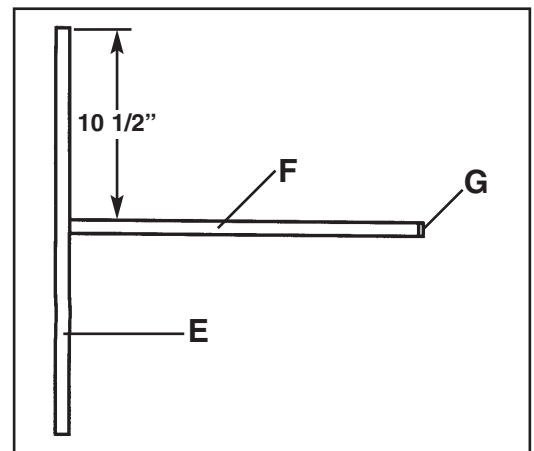

Figure 3
Subassembly (E, F, G)

Assembly Instructions

Page Two

Read all instructions before beginning any work. Cut all material to sizes shown in cutting schedule.

4. Drill 3/8" holes in boards (A), (B) and (C). Refer to Figure 4.
5. Assemble side frame subassemblies (A, B, C) using glue and 3/8" dowels. Refer to Figure 4 and Isometric.
6. Route a 1/2" deep by 3/8" wide rabbet on the inside edges of side frame subassemblies (A, B, C). Refer to Figure 4.
7. Glue side panels (D) into rabbets in side frame subassemblies (A, B, C). Refer to Figure 4 and Isometric.

Figure 4
Subassembly (A, B, C, D)

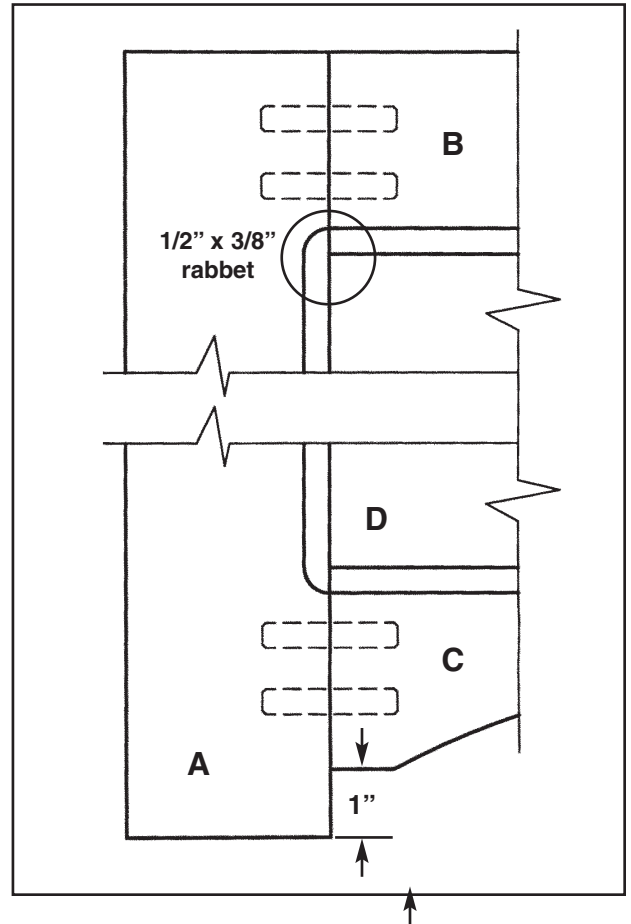

8. Attach sides (A, B, C, D) to subassembly (E, F) using glue and 1 1/2" finish nails. Refer to Isometric.

9. Attach front base board (I) to boards (A) using glue and 1 1/2" finish nails. Refer to Figure 5 and Isometric.

Figure 5
Relative Position of Boards (A) and (I)

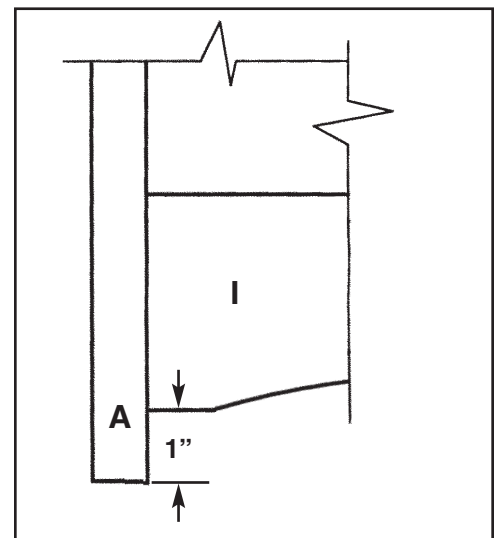

Assembly Instructions

Page Three

Read all instructions before beginning any work. Cut all material to sizes shown in cutting schedule.

- Attach front panel (H) to boards (A) and (F) using glue and 1 1/2" finish nails. Note that board (H) is inset 1/4" from the outside edges of boards (A) and (G). Refer to Isometric.

- Attach top board (J) to boards (A) and (E) using glue and 1 1/2" finish nails. Refer to Figure 6 and Isometric.

Figure 6
Relative Position of
Boards (A), (E) and (J)

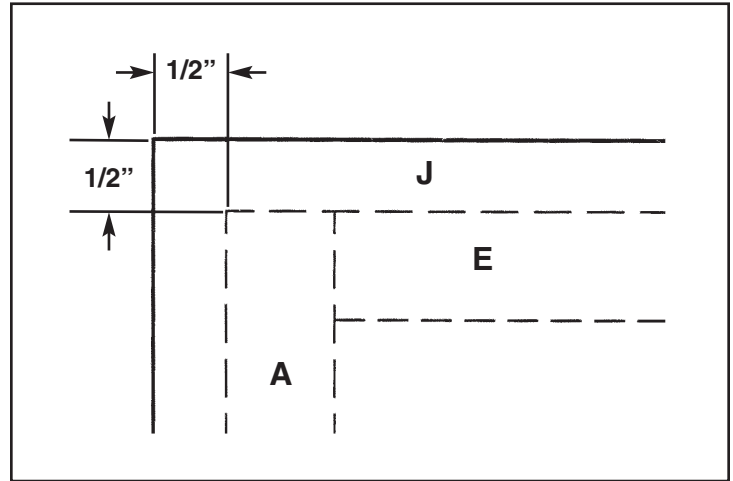

- Attach top (K) to board (J) using butt hinges. Refer to Isometric.

- Cut a 1/4" deep by 1/2" wide dado in drawer sides (L). Refer to Figure 7.

- Assemble drawer (L, M, N, O) using glue and 1" finish nails. Refer to Figure 7 and Isometric.

Figure 7
Relative Position of
Boards (L), (M), (N) and (O)

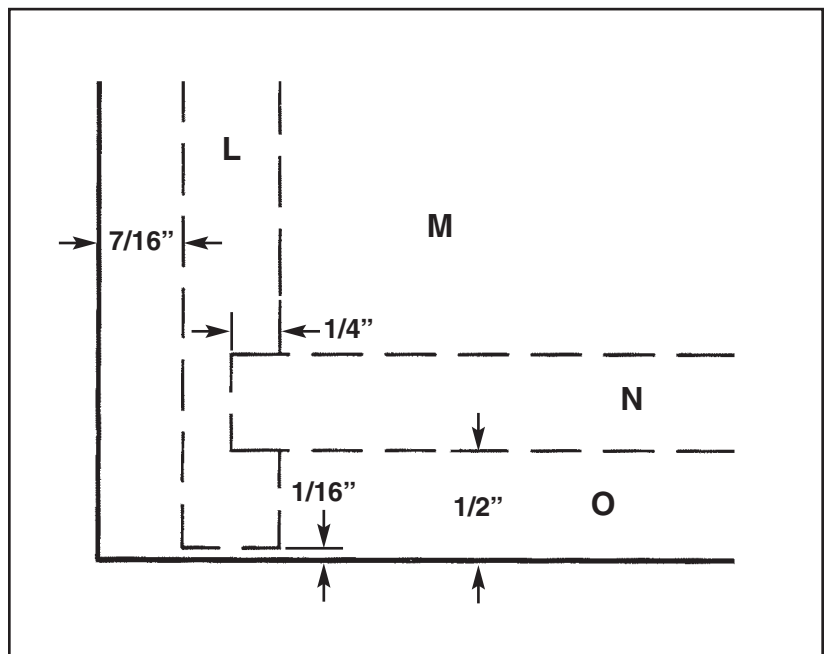

- Install drawer (L, M, N, O) following drawer slide manufacturer's instructions. Refer to Isometric.

Assembly Instructions

Page Four

Read all instructions before beginning any work. Cut all material to sizes shown in cutting schedule.

16. Apply finish of choice.

17. Install drawer knobs.